







ST 050 304 6360



- Ausladung Standbrause 420 mm
- Regenbrause: PURE RAIN, Durchfluss max. 14 l/min (bei 3 Bar)
- Funktion ab: 8 l/min
- Regenbrause Ø 200 mm
- Regenbrause mit Antikalk-System
- Handbrause: Dreifach bzw. fünffach verstellbar: COMPACT RAIN, COMPACT SOFT FLOW, COMPACT AQUAPRESSURE FLOW, Durchfluss max. 9 l/min (bei 3 Bar)
- Brausekopf Ø 95 mm
- Drehumstellung Standbrause/ Handbrause
- Höhe Armatur bis Regenbrause (Unterkante) 985 mm
- Höhe Armatur bis Oberkante Bogen 1160 mm
- zweiteilige Schubrosetten Ø 65 mm
- Rosette für Brausehalter Ø 65 mm
- Rosette für Wandbefestigung Ø 60 mm
- Stichmaß 150 mm ± 13 mm
- Metallbrauseschlauch 1250 mm mit integriertem Verdrehenschutz
- Anschluss 1/2"
- Rohrdurchmesser 20 mm

	Chrom	ST 050 304 6360-00
	Platin gebürstet	ST 050 304 6360-06
	Platin	ST 050 304 6360-08
	Messing (23kt Gold)	ST 050 304 6360-09
	Messing gebürstet (23kt Gold)	ST 050 304 6360-28
	Dark Platinum gebürstet	ST 050 304 6360-99

**Einzelkomponenten dieses Sets**



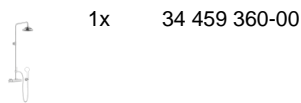
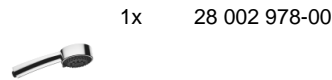



Für dieses Set benötigen Sie folgende Komponenten





ST 050 304 6360



	Chrom	11 420 360-00
	Platin gebürstet	11 420 360-06
	Platin	11 420 360-08
	Messing (23kt Gold)	11 420 360-09
	Messing gebürstet (23kt Gold)	11 420 360-28
	Dark Platinum gebürstet	11 420 360-99





ST 050 304 6360



ST 050 304 6360

Ersatzteile für die  
anderen  
Oberflächenvarianten  
finden Sie hier: Platin  
gebürstet

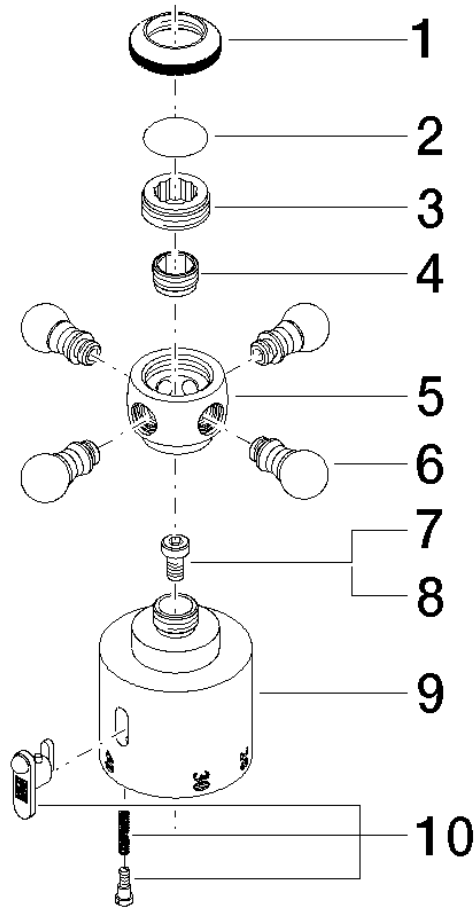

**Ersatzteilstückliste**

Nr.	Artikelnummer	Benennung	Verbaumenge	Lieferzeit
1	09 20 36 005-00	Griff	1	10
2	09 26 01 016 90	Zubehoer	1	2
3	09 20 83 006 90	Griff	1	2
4	09 24 03 119 90	Nippel	1	2
6	09 20 36 004-00	Griff	4	10
7	90 30 30 027 00 90	Schraube	1	2
8	09 30 33 004 90	Schraube	1	2
10	90 21 33 020 00 90	Griff	1	2

ST 050 304 6360



- Dreifach verstellbar: COMPACT RAIN, COMPACT SOFT FLOW, COMPACT AQUAPRESSURE FLOW, Durchfluss max. 9 l/min (bei 3 Bar)
- mit Antikalk-System
- Brausekopf Ø 95 mm
- Anschluss 1/2"

Eigensicher gegen Rückfließen.

	Chrom	28 002 978-00
	Chrom	28 002 978-00 0010
	Platin gebürstet	28 002 978-06
	Platin gebürstet	28 002 978-06 0010
	Platin	28 002 978-08
	Platin	28 002 978-08 0010
	Messing (23kt Gold)	28 002 978-09
	Messing (23kt Gold)	28 002 978-09 0010
	Messing gebürstet (23kt Gold)	28 002 978-28
	Messing gebürstet (23kt Gold)	28 002 978-28 0010
	Chrom gebürstet	28 002 978-93
	Chrom gebürstet	28 002 978-93 0010
	Dark Platinum gebürstet	28 002 978-99
	Dark Platinum gebürstet	28 002 978-99 0010





ST 050 304 6360

mm [inches]

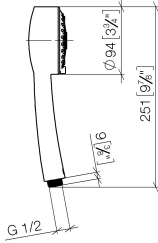

### Durchflussdiagramm

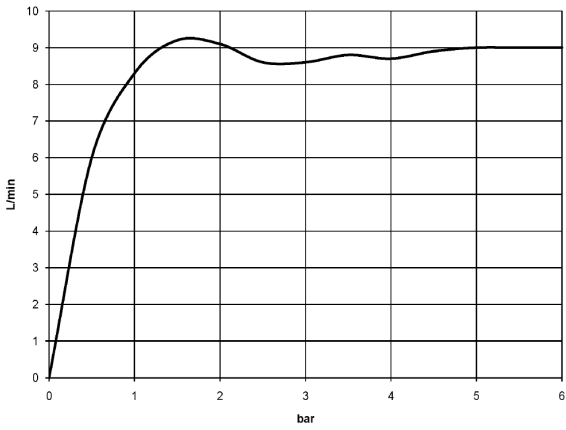

### Zertifikate

LGA\_18610.

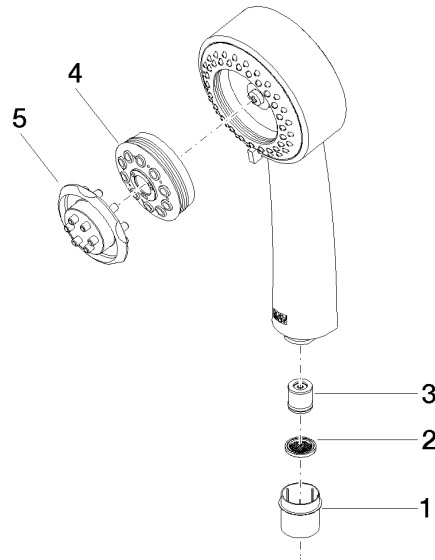







**Ersatzteilstückliste**

Nr.	Artikelnummer	Benennung	Verbaumenge	Lieferzeit
1	09 21 02 115 90	Kappe	1	2
2	09 23 01 039 90	Sieb	1	2
3	09 23 01 077 90	Durchflussbegrenzer	1	2
4	04 12 11 071 00 90	Brause	1	2
5	09 30 09 022 90	Schlüssel	1	2

ST 050 304 6360



- Ausladung Standbrause 420 mm
- Regenbrause Ø 200 mm
- Regenbrause mit Antikalk-System
- Durchfluss Regenbrause max. 14 l/min (bei 3 Bar)
- Funktion ab: 8 l/min
- Drehumstellung Standbrause/ Handbrause
- Höhe Armatur bis Regenbrause (Unterkante) 985 mm
- Höhe Armatur bis Oberkante Bogen 1160 mm
- zweiteilige Schubrosetten Ø 65 mm
- Rosette für Brausehalter Ø 65 mm
- Rosette für Wandbefestigung Ø 60 mm
- Stichmaß 150 mm ± 13 mm
- Metallbrauseschlauch 1250 mm mit integriertem Verdrehenschutz
- Anschluss 1/2"
- Rohrdurchmesser 20 mm

	Chrom	34 459 360-00
	Platin gebürstet	34 459 360-06
	Platin	34 459 360-08
	Messing (23kt Gold)	34 459 360-09
	Messing gebürstet (23kt Gold)	34 459 360-28
	Dark Platin gebürstet	34 459 360-99

Dieser Artikel enthält keine Handbrause!

Eigensicher gegen Rückfließen.

**ACHTUNG:** Die Griffe müssen separat zu den Armaturen bestellt werden!



ST 050 304 6360

1:10

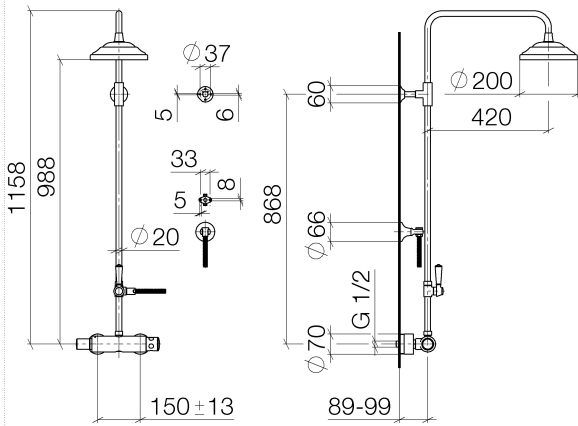

**Durchflussdiagramm**

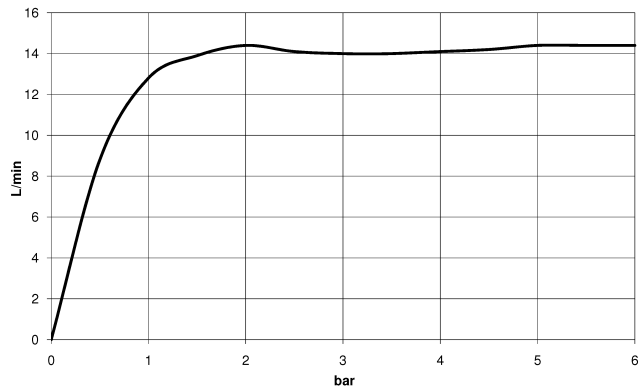

**Zertifikate**

LGA\_38665.

ST 050 304 6360

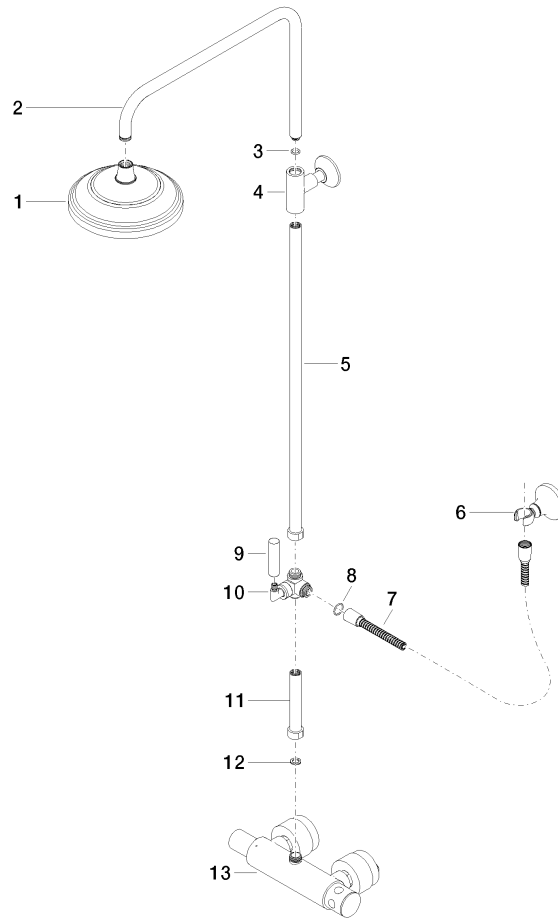

**Ersatzteilstückliste**

Nr.	Artikelnummer	Benennung	Verbaumenge	Lieferzeit
1	04 12 05 038 01-00	Brause	1	60
2	04 28 22 101 20-00	Auslauf	1	10
3	90 14 10 011 00 90	Dichtung	1	2
4	90 17 11 037 01-00	Halter	1	10
5	90 28 22 104 00-00	Rohr	1	10
6	28 050 410-00	Halter	1	60
7	28 104 970-00	Metall-Brauseschlauch 1/2" x 1/2" x 1250 mm - Chrom	1	2
8	09 14 10 122 90	Dichtung	1	2
9	11 170 370-00	MADISON Hebeleinsatz - Chrom	1	10
10	90 17 09 045 01-00	Umstellung	1	10
11	90 28 22 103 00-00	Rohr	1	10
12	90 14 20 002 00 90	Dichtung	1	2
13	04 17 01 044 01-00	Armatür	1	10